

Universal Replacement Coils

Installation Manual

CCG & MCG "E" Series Coils

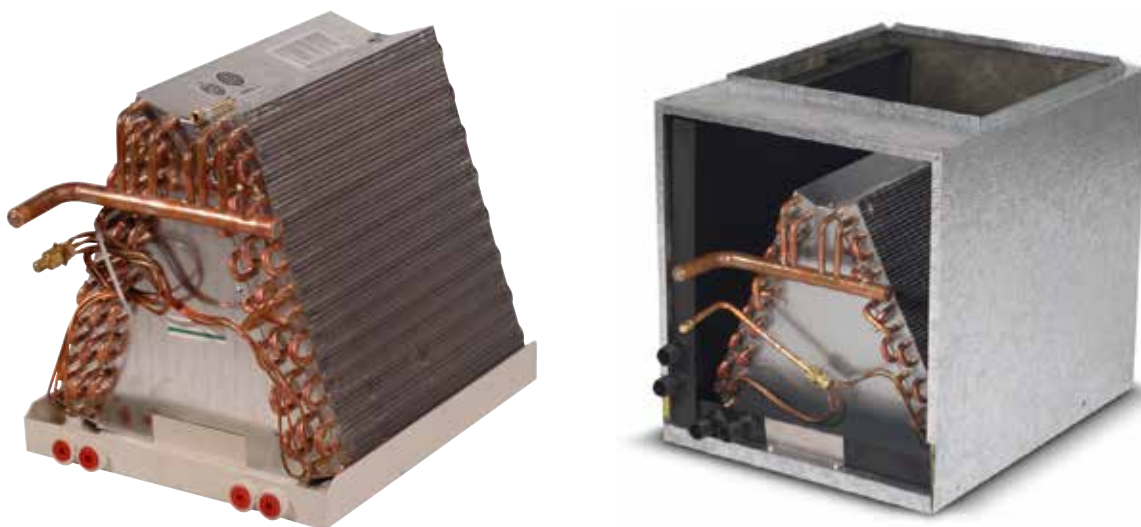

INSTALLATION GUIDE

CCG Series - Uncased Upflow/Downflow Coils MCG Series - Cased Multi-Position Coils

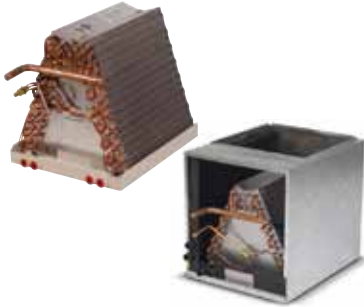

1. Safety Instruction

Potential safety hazards are alerted using the following symbols. The symbol is used in conjunction with terms that indicate the intensity of the hazard.



WARNING This symbol indicates a potentially hazardous situation, which if not avoided, could result in serious injury, property damage, product damage or death.



CAUTION This symbol indicates a potentially hazardous situation, which if not avoided, may result in moderate injury or property damage.



WARNING Certified technicians or those individuals meeting the requirements specified by NATE may use this information. Property and product damage or personal injury hazard may occur without such background.



WARNING All power sources should be disconnected prior to servicing. Failure to do so may cause personal injury or property damage.



WARNING Product designed and manufactured to permit installation in accordance with local and national building codes. It is the installer's responsibility to ensure that product is installed in strict compliance with national and local codes. Manufacturer takes no responsibility for damage (personal, product or property) caused due to installations violating regulations.

As expressed in our product warranty; **WE WILL NOT BE BILLED FOR ANY STRUCTURAL DAMAGES CAUSE BY FAILURE TO FOLLOW THIS INSTALLATION REQUIREMENT.**



CAUTION Drain lines from the auxiliary drain pan should NOT be connected to the primary drain line of the coil.



WARNING Do NOT install coils with plastic drain pans on any OIL or DRUM type furnaces or applications where temperature of the drain pan might exceed 260 ± 5 °F. A metal pan should be installed in these applications.

✓ Install cased coils with plastic drain pans on a level, flat surface. In case of coils with metal drain pans, slope the coil $\frac{1}{4}$ " towards the drain. No such pitch is necessary in the case of plastic drain pans. Condensate drain lines must be installed in accordance with local building codes.

✓ The drain lines must be installed with $\frac{1}{4}$ " per foot pitch to provide free drainage. A condensate trap MUST be installed on the primary drain line to ensure proper drainage of the condensate. The trap must be installed in the drain line below the bottom of the drain pan. Fig. 4-1 illustrates the typical drain trap installation.

Fig 4-1. Typical drain line trap set up

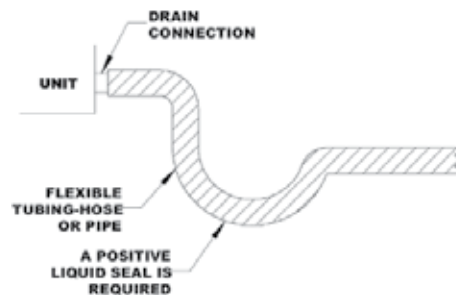

CAUTION If the drain pan is constructed of nylon or plastic; use Teflon tape to connect the drain lines to the threads in the drain pan. **DO NOT USE SOLVENT BASED PIPE DOPE. THIS WILL REDUCE THE LIFE OF THE PAN.**

2. Inspection

✓ On receiving the product, visually inspect it for any major shipping related damages. Shipping damages are the carrier's responsibility. Inspect the product labels to verify the model number and options are in accordance with your order. Manufacturer will not accept damage claims for incorrectly shipped product.

3. Installation Preparation

✓ Read all the instructions in this guideline carefully while paying special attention to the WARNING and CAUTION alerts. If any of the instructions are unclear, clarify with a certified technician before proceeding. Gather all tools needed for successful installation of the unit prior to beginning the installation.

4. Condensate Drain Preparation

✓ We recommend an auxiliary drain pan be provided by the installer. Drain pan should be properly sloped, installed according to local building codes, and terminated in an area visible to the home owner. The auxiliary pans provide extra protection to the area under the unit should the primary and secondary drain plug up and overflow.

✓ The drain pan has primary and secondary drain connections. If a secondary drain line is required, it should be run separately from the primary and should terminate in a highly visible location. Condensate disposal through the secondary drain line indicates that the primary drain line is plugged and needs cleaning. If a secondary drain line will not be provided plug the secondary drain. Drain plugs are NOT to be reused without plumbers tape or putty. Drain line connection should be finger tightened, then turned no more than one complete turn as needed to ensure a firm connection. DO NOT overtighten connection or damage may occur.

5. Coil Installation



WARNING The coil is manufactured with dry nitrogen pre-charge. Release the pressure through the Schrader valve test port prior to installation. If holding pressure is not present, return coil to distributor for exchange.

✓ Clean coil fins with degreasing agent or mild detergent and rinse fins clean prior to installation.

✓ The refrigerant line sizes should be selected according to the recommendations of the outdoor unit manufacturer.

✓ Care must be taken to ensure all connection joints are burr-free and clean. Failure to do so may increase chances of a leak. It is recommended to use a pipe cutter to remove the spun closed end of the suction line.

✓ To reduce air leakage, rubber grommets may be present where the lines pass through the coil case. To avoid damage, remove grommets prior to brazing by sliding over the lines. Use a quenching cloth or allow the lines to cool before reinstalling the grommets.

✓ Use of wet rags/quenching cloth is highly recommended to prevent weld-related damages to the casing and Schrader valve (if present).

✓ CCG (Uncased Coils) and MCG (Multi-Position) can be installed in either an upflow or a downflow application.



CAUTION Coil should be installed on the discharge side of the furnace



CAUTION Some coils may include a Schrader valve on the suction manifold. Ensure that the Schrader valve and valve core (where present) are protected from heat to prevent leakage.



WARNING As mentioned elsewhere in this document, in an application involving oil furnace a metal drain pan **MUST** be used. Coils installed on an oil furnace must have a minimum of six inches clearance between the top of the furnace and bottom of the drain pan.



CAUTION Multi-position (MCG) Coils are shipped from the factory for specific horizontal applications (horizontal right or horizontal left). Installer must ensure that the coil is installed in the orientation for which it was intended (horizontal drain pan side down). Failure to follow these instructions might lead to property and equipment damage.

5A. Vertical Upflow/Downflow Installation (CCG&MCG)



CAUTION When installing in conjunction with a gas furnace in a vertical orientation, ensure that there is 2" gap between the bottom of the drain pan and the outlet of the furnace.

To set up coils for downflow application, install the two 3" wide by 16" long galvanized metal plates on the outside of the coil, against the fins on each side of the coil as shown in Fig. 5A-3. These plates are supplied with the coil.

Do NOT exceed 350 cfm/ton of airflow for downflow applications.

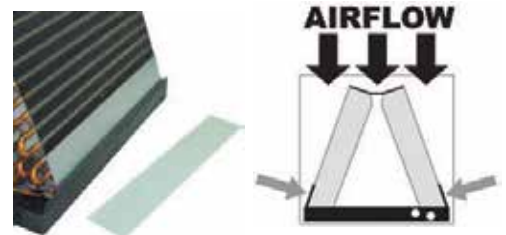

Counter flow configuration

Fig 5A-3. Metal Plate location for a Downflow/Counterflow Application

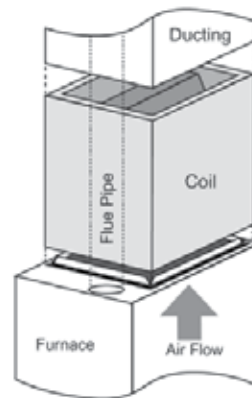

Fig 5A-1. Upflow Application

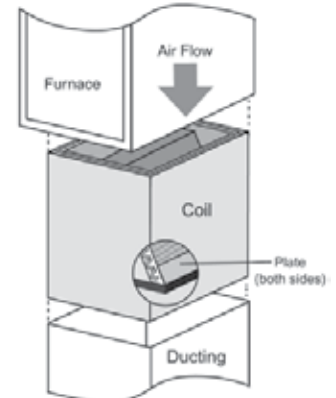

Fig 5A-2. Downflow Application

To position the coil on furnace:

1. Locate the air outlet of the furnace.
2. Adjust flanges accordingly and position the coil over or under the furnace outlet.
3. Place ductwork over the casing.

Refer to Furnace/Air Handler manufacturer literature for specific coil installation guidelines and recommendations

5B. Horizontal Installation (MCG Only)

Multi-position coils (MCG) are shipped from the factory such that they can be installed in both vertical and horizontal applications without changes to the coil. When installing these coils in the horizontal application, the details mentioned in this section must be followed.

Multi-position (MCG) coils come equipped with a horizontal drain pan (Plastic/Metal). The plastic drain pan is protected from high temperatures by a metal plate at the apex end of the coil.

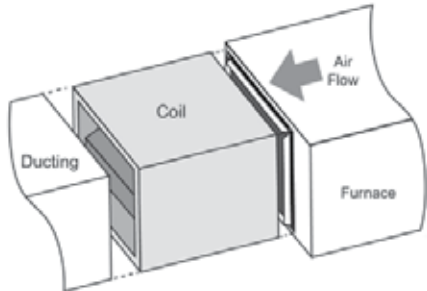
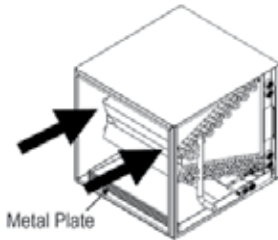

Fig 5B-1. Horizontal Left Application



When installing in horizontal applications with airflow directed into the apex of the coil, ensure the presence of the metal plate on the drain pan as shown. Absence of the plate in this configuration may expose the drain pan to high temperatures and increase the chances of property damage due to fire or electric hazard.

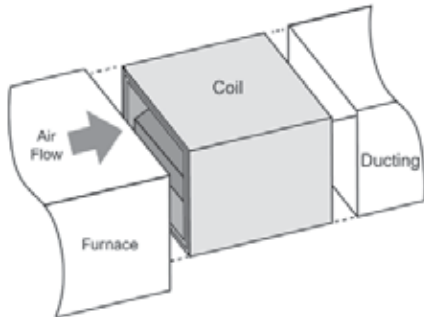

Fig 5B-2. Horizontal Right Application

Refer to Furnace/Air Handler manufacturer literature for specific coil installation guidelines and recommendations.

6. Suction Line Connection



WARNING

The sensing bulb and TXV body **MUST** be protected from overheating during brazing. The sensing bulb and TXV body must be covered using a quench cloth or wet cloth when brazing. Pointing the brazing flame away from the valve and sensing bulb provide partial protection only.



CAUTION

Some coils may include a Schrader valve on the suction manifold. Ensure that the Schrader valve and valve core (where present) are protected from heat to prevent leakage.

1. Ensure suction line connection joints are burr-free and clean. Failure to do so may increase chances of a leak and introduce contaminants to the system. It is recommended to use a pipe cutter to remove the spun closed end of the suction line.

2. Swedge (or use a field supplied coupler) and braze the field supplied refrigerant suction line tubing to the coil stub using approved industry practices.



WARNING

Do not attempt to touch brazed joints while hot. Severe burns may result.

7. Metering Devices/Liquid Line Connection

Our coils are available with two kinds of metering devices a) flowrator or b) TXV. The following instructions are separated into sections by metering device.

7A. Flowrator Coils

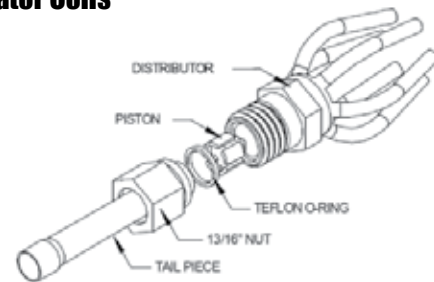

Fig 7A-1. Flowrator assembly components



CAUTION

Use Piston sizes recommended by the outdoor unit manufacturer whenever possible. The piston should be sized according to the capacity of the outdoor unit.



WARNING

Failure to install the proper piston can lead to poor system performance and possible compressor damage.

I. Installation

Note: Photos are for basic illustration purposes only. Actual equipment configuration may differ from that shown.



I-1. Disassemble flowrator body using two wrenches and unscrewing with a counterclockwise motion.

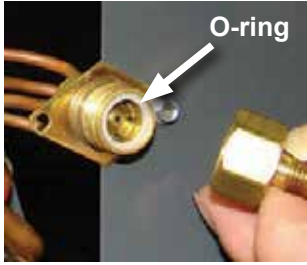

I-2. Replace the Teflon O-ring (located between the halves). Discard Schrader if present.

CAUTION Be aware of the Teflon O-ring. Be sure to replace the O-ring to attain a proper seal. (The Teflon O-ring is located between the two halves of the flowrator)



I-3. Slide the attachment nut onto the liquid line stub out.

I-4. Braze the stub-out portion to the liquid line and let cool.

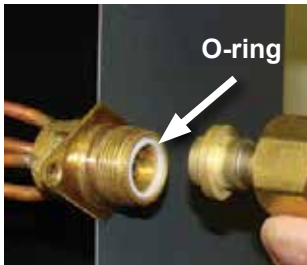

I-5. Taking care that the white Teflon seal is still in place inside the flowrator body, firmly seat the stub and screw the attachment nut to flowrator body.

I-6. Tighten the nut to a torque of approximately 10-30 ft-lbs. Do NOT overtighten the nut. Overtightening will impede the piston movement during operation.

II. Piston Replacement

Note: Photos are for basic illustration purposes only. Actual equipment configuration may differ from that shown.



Fig 7A-2

During some installations, a piston change may be required. If so, the installer **MUST** change the piston. Use piston sizes recommended by the outdoor unit manufacturer. If a sizing chart is not available, use the piston size chart provided below to size the required piston. The size of the piston is stamped on the piston body (Fig 7A-2).

Use the chart below when matching coil with an outdoor unit with a different nominal capacity than the coil.

| Outdoor Unit Capacity | R22 Orifice Size | R410a Orifice Size |
|-----------------------|------------------|--------------------|
| 12,000 | 0.041 | N/A |
| 18,000 | 0.055 | 0.049 |
| 24,000 | 0.059 | 0.055 |
| 30,000 | 0.068 | 0.059 |
| 36,000 | 0.074 | 0.068 |
| 42,000 | 0.080 | 0.074 |
| 48,000 | 0.084 | 0.080 |
| 60,000 | 0.092 | 0.089 |

II-1. Evacuate the system as per manufacturer guidelines and recommendations

II-2. Turn the 13/16" nut once to release any residual pressure in the coil.



II-3. After ensuring that the coil is free of any residual pressure, disassemble the flowrator body completely using two wrenches. Take great care not to distort the feeder tubes. The wrench used to clasp the nut should be turned in counter-clockwise direction to unscrew the nut.



II-4. Slide the 13/16" nut over the lineset and separate the two halves of the flowrator.



II-5. Pull the piston out using a small wire or pick. Verify the piston size (size is typically stamped on the body of the piston - Fig 7A-2). If a different piston size is required by the outdoor unit manufacturer, replace the piston using the small wire provided with the piston kit.



II-6. Replace the piston with one of the correct size. Do not force the new piston into the body. Make sure the piston moves freely in body.

CAUTION Pay close attention to the piston orientation. The pointed end of the piston **MUST** go into the distributor body, towards the coil. Failure to ensure this orientation will cause the piston to be bypassed during operation which might damage the outdoor unit.

II-7. Assemble the two halves correctly and ensure that the Teflon O-ring is present between the two halves (See I-5). Slide the 13/16" nut onto the distributor body.

CAUTION Be aware of the Teflon O-ring. Be sure to replace the O-ring to attain a proper seal. (The Teflon O-ring is located between the two halves of the flowrator)

II-8. Tighten the nut to a torque of approximately 10-30 ft-lbs. **Do NOT overtighten the nut.** Overtightening will impede the piston movement during operation.

II-9. If present, slide the rubber grommet back to position to prevent air leakage.

7B. TXV Coils

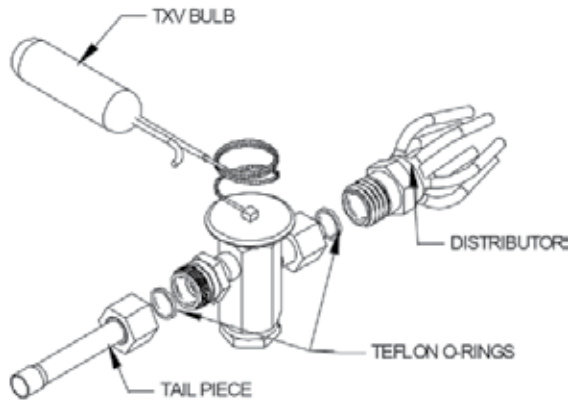

Fig 7B-1. Components of a typical TXV assembly



WARNING

The sensing bulb and TXV body **MUST** be protected from overheating during brazing. The sensing bulb and TXV body must be covered using a quench cloth or wet cloth when brazing. Pointing the brazing flame away from the valve and sensing bulb provide partial protection only.



CAUTION

Ensure that the TXV selected is compatible with the refrigerant used in the outdoor system (R22 or R410A). TXV caps are painted green for R22 or pink for R410A. In absence of color, the caps will be marked with the compatible refrigerant.



CAUTION

The valves should be sized according to the capacity of the outdoor unit. Failure to install the right valve can lead to poor performance and possible compressor damage.

I. TXV Bulb Horizontal Mounting

The orientation and location of the TXV bulb has a major influence on the system performance.



CAUTION

Ensure that the TXV bulb is in direct contact with the suction/vapor line. Gap between the bulb and tube should be avoided. Failure to do so will impair the proper functioning of the TXV valve.

It is recommended that the TXV bulb be installed parallel to the ground (on a horizontal plane). The bulb position should be at 2 o'clock or 10 o'clock. Fig. 7B-2 shows the recommended position for the TXV bulb installation in the horizontal plane.

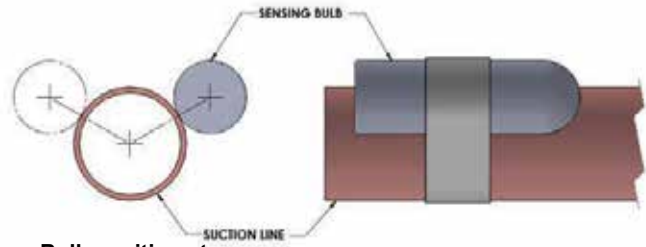

Bulb position at
2 o'clock or
10 o'clock

Fig 7B-2. Recommended location for horizontal TXV bulb mount

The TXV sensing bulb **SHOULD** be mounted on the suction line approximately 6" from the TXV or coil housing using the metal clamp provided. In order to obtain a good temperature reading and correct superheat control, the TXV sensing bulb must conform to ALL of the following criteria:

1. The sensing bulb **MUST** be in direct and continuous contact with the suction line.
2. The sensing bulb should be mounted horizontally on the suction line.
3. The sensing bulb **MUST** be mounted at the 2 o'clock or 10 o'clock position on the circumference of the suction line.
4. The sensing bulb **MUST** be insulated from outside air.

A properly mounted sensing bulb will prevent false readings caused by liquid refrigerant that may have formed inside the suction/vapor line. Insulation will protect the sensing bulb from false readings due to contact with warm air.

II. TXV Bulb Vertical Mounting

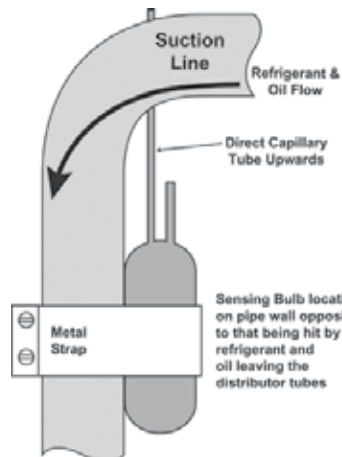

Fig 7B-3. Recommended location for vertical TXV bulb mount

As recommended in Section 7B-1, the TXV sensing bulb should be mounted in a horizontal plane in relation to the suction/vapor line. However, some installation configurations may require that the sensing bulb be mounted vertically. In this instance, place the bulb opposite the piping wall being hit by refrigerant and oil leaving the distributor tubes, and with capillary tubes directed upwards as shown in Fig. 7B-3.



CAUTION

If the TXV sensing bulb is mounted vertically; the capillary **MUST** be directed upwards. The bulb must be mounted on the wall opposite to that being directly hit by the refrigerant and oil leaving the distributor tubes.

III. Field-Installed TXV Retrofit

Note: Photos are for basic illustration purposes only. Actual equipment configuration may differ from that shown.

When installing an expansion valve, it is not necessary to slide the coil out of the housing.



III-1. Disassemble the flowrator body using two wrenches. Unscrew the body with a counter-clockwise motion.



III-2. Remove the existing flowrator piston using a small wire or pick.

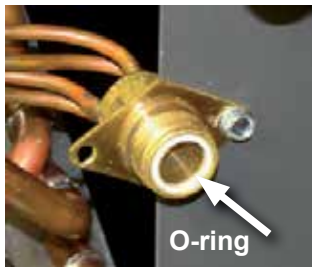

III-3. Replace the Teflon O-ring seal in place (located between the halves).

III-4. Inspect the TXV box to confirm that the valve is compatible with the refrigerant in the system.

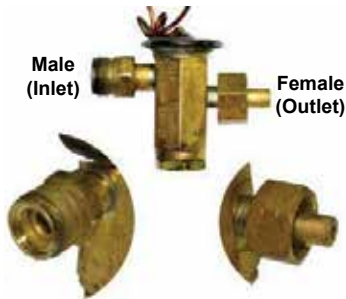

III-5. Remove the valve from the box and note the location of the inlet side (threaded male port) and the outlet side (female swivel nut port).



III-6. After ensuring that the Teflon O-ring seal is still in place inside the flowrator body, screw the female swivel nut onto the flowrator body.

III-7. Slide attachment the nut onto the liquid line stub out (See 7A, I-3)

III-8. Braze the stub-out portion to the liquid line and let cool.

WARNING Do not attempt to touch brazed joints while hot. Severe burns may result.



III-9. Remove the additional Teflon O-ring seal from the box and place on the shoulder just inside the TXV inlet port. Screw the nut attached to the stub-out portion of the flowrator body onto the inlet port of the TXV.

III-10. Tighten all connections taking care to use proper back up.

III-11. Remove the valve identification sticker from the valve and place it adjacent to the Aspen model number on unit name plate.

III-12a. Some coils come with a Schrader valve on the suction line. **If a Schrader port is present:**



A. Remove the valve stem from the Schrader port mounted on the suction line.



B. Screw flare nut on TXV equalization tube on to the Schrader valve stem.

III-12b. In some cases, a suction line schrader port may not be present. **If a Schrader port is NOT present:**



A. Install a field-supplied braze-on schrader valve like that shown on the suction line near the intended sensing bulb mounting location. Follow valve manufacturer instructions and recommendations for installation.

B. Attach equalizer tube to valve as described in section III-12a above.

III-13. Mount the sensing bulb as described in section 7B-I or 7B-II.

CAUTION When handling or manipulating the equalizer tube, take great care not to kink or make extreme bends in the tubing.

CAUTION

Using a non-bleed expansion valve may require the use of a hard-start kit. Follow the outdoor unit manufacturer's guidelines.

8. Leak Check

1. Following outdoor unit manufacturer instructions and recommendations, charge the system with dry nitrogen to a maximum pressure of 150 PSIG.



2. Check all brazed and screw-on line connections by applying a soap solution to the joint. A leak will produce bubbles in the soap solution.

3. If any leaks or are discovered, relieve system pressure and repair leaks. Repeat steps 1-3.

4. With no leaks or weak connections present, evacuate the system and charge as per the outdoor unit manufacturer instructions and specifications.

9. System Charging

CAUTION

An improperly charged system will likely cause loss in system performance and may damage the compressor.

CAUTION

Refer to outdoor unit manufacturer charging guidelines and recommendations. The recommendations given below are general in nature and are NOT to supersede outdoor unit manufacturer specifications.

2A. Flowrator coils: Add refrigerant until the superheat measured at the outdoor unit suction/vapor line matches the superheat from the chart below.

| Outdoor Temp | Superheat | | | |
|--------------|-----------|-----|-----|-----|
| | °F D.B. | Min | Nom | Max |
| 65 | | 30 | 35 | 40 |
| 70 | | 26 | 30 | 34 |
| 75 | | 21 | 25 | 29 |
| 80 | | 17 | 20 | 23 |
| 85 | | 12 | 15 | 18 |
| 90 | | 8 | 10 | 12 |
| 95 | | 4 | 5 | 7 |
| 100 | | | | |

2B. TXV coils: Add refrigerant until the subcooling measured at the outdoor unit liquid line matches the subcooling recommendation of the outdoor manufacturer. If chart is unavailable charge the unit to a subcooling value of 8°F +/- 1°F.

Due to ongoing product improvements, specifications and dimensions are subject to change and correction without notice or incurring obligations. Determining the application and suitability for use of any product is the responsibility of the installer. Additionally, the installer is responsible for verifying dimensional data on the actual product prior to beginning any installation preparations.

Incentive and rebate programs have precise requirements as to product performance and certification. All products meet applicable regulations in effect on date of manufacture; however, certifications are not necessarily granted for the life of a product. Therefore, it is the responsibility of the applicant to determine whether a specific model qualifies for these incentive/rebate programs.

1900 Wellworth Ave., Jackson, MI 49203 • Ph. 517-787-2100 • www.marsdelivers.com

